

GB Operating Instructions MIL 72/1 digi 42

WA-EKF 3056/10.97/S:MMS/D:Str./80.10.0741.7/97/00538

1. Putting into operation

Electrical units may only be installed and assembled by a skilled electrician. (The term "skilled electrician" is defined in VDE 0105).

Notes:
The unit contains well-designed electronic components which are largely protected against external interference. However, it must be remembered that extremely high interference voltage peaks can be superimposed on the mains voltage, depending on the installation site. Interference which, despite all internal protective measures, can also affect an electronic unit also arises when contactors are switched. In order to guarantee the greatest possible operational reliability, the following details must be observed:

- In the case of larger systems, a suitable varistor or RC element must be used to provide interference suppression for contactor coils directly switched by the time switch.
- If inductive direct current loads are switched, a suppressor diode must be installed.
- Inductive loads and particularly fluorescent lamps place particular demands on the output contacts. In each individual case, check whether it is appropriate to install an isolating relay or contactor.

2. Assembly and connection

2.1 Surface-mounting

Fit the base in accordance with local conditions. Fit the time switch and secure with the screws (A).

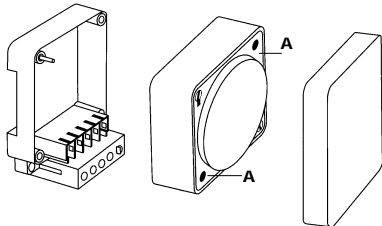

2.2 Connection

See unit imprint/circuit diagram.

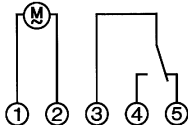

2.3 Assembly with terminal cover

Fit the base in accordance with local conditions, connect and attach the terminal cover article-number 01.78.0004.6. Then fit the time switch and secure with the screws (A).

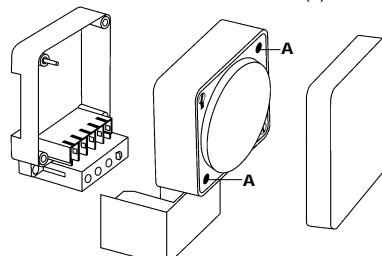

3. Sealing with sealing glass – IP 40

Seal using the accessory sealing glass – attach and seal the sealing glass, article number 01.78.0016.6. The sealing glass can only be removed with a suitable tool.

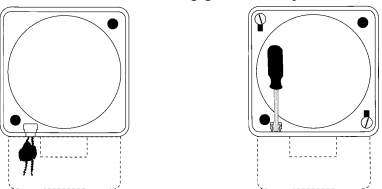

4. Operating the time switches

The steps marked with the symbol are necessary to carry out a switching program.

4.1 Reset

Press the "Reset" key with a pencil or similar object. This sets the time switch to its basic setting.
– before every restart
– to delete all switching times and the time (with the exception of the standard program)
The following appears after approximately 2 seconds:

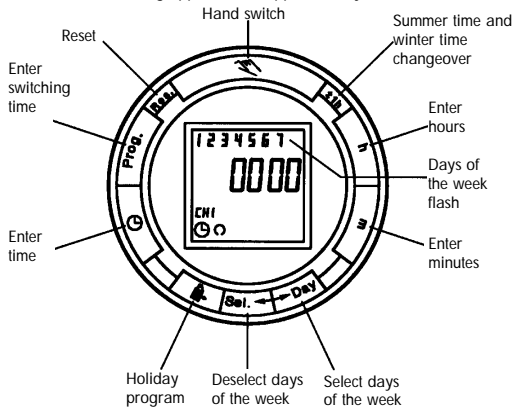

4.2 Entering the time and current day of the week

- After pressing the "Res" key (see 4.1):
 - During the summer time period: press the "±1h" key once.
 - Keep the "⊙" key pressed during steps 4, 5 and 6.
 - With the "h" key: enter the hours
 - With the "m" key: enter the minutes
 - With the "Day" key: enter the current day 1 = Mo ... 7 = Su
 - Release the "⊙" key
- The colon now flashes at one second intervals.

Note:
If the "h/m" keys are pressed for longer than 2 seconds, the display will enter fast-forward scroll mode.

4.3 Entering the switching times

- 42 memory locations are available. Each switching time occupies 1 memory location.
- Keep pressing the "Prog." key until a free memory location "-- : --" is shown in the display.
 - Select the switching functions "⊙" (ON) or "⊖" (OFF) with the "⊙" key.
 - With the "h" key: enter the hours
 - With the "m" key: enter the minutes

If a switching command is to be executed every day, proceed with step 6. If 1 switching command is to be executed only on one day or on certain days skip step 5 and continue with step 6.

- Save with the "Prog." key or
 - With the "Day" key, select 1 day on which the switching command is not to be carried out (cursor flashes)
 - Confirm this day with the "Sel." key (day of the week and cursor flash)
 - Press the "Day" key (day is deselected).
- Repeat steps 6, 7 and 8 for every day to be deselected.

- Save with the "Prog." key (the next free memory location is displayed) or
- Save with the "⊙" key.

The time switch goes over to automatic mode and displays the current time.

Begin every additional switching time and the associated switching state = ON or = OFF again with 4.3.

Note:
If an input is incomplete, the segments still not selected are displayed flashing

If you have deselected a day on which the switching command should be carried out,

- Reselect the deselected day with the "Day" key (day of the week and cursor flash).
- Confirm this day with "Sel." (cursor flashes).
- Press the "Day" key (day is reselected).
- Save with the "Prog." key (the next free memory location is displayed) or
- Save with the "⊙" key.

Note:
Note what position the switch is in, ON or OFF . Depending on the switching program and the time of day, select the desired switch position with the key . (For channel 1 and/or 2) e.g.

5. Additional functions

5.1 Summer time and winter time setting

- Press the "±1h" key once.

5.2 Automatic summer time/winter time changeover

The following 3 changeover variants are available:

AU (Automatic) = fixed changeover

The S/W time changeover is performed on the basis of a predefined calendar program which is permanently programmed up until the year 2079 and cannot be changed.

(Statutory summer time ruling of the European Union and Switzerland).

Start of summer time: Always the last Saturday in March.

The hour is advanced by one hour from 2 to 3.

End of summer time: Always the last Saturday in October.

The hour is moved back by one hour from 3 to 2.

CHA (calculated semi-automatic) = freely selectable changeover with weekday reference

You enter the valid summer time starting date for your country (e.g. date of the last Friday in April of the current calendar year) and also the date on which summer time ends (e.g. date of the first Tuesday in October of the current calendar year). The program automatically assigns to this date the correct day of the week (in this case Friday and Tuesday). In the subsequent years, the time changeover always takes place on the calculated day of the week, irrespective of the date (in this case the last Friday in April and the last Tuesday in October).

HA (semi-automatic) = freely selectable changeover with date reference

You enter the valid summer time starting and end dates for your country. In the subsequent years, the time changeover always takes place on the same date.

Activation of the automatic summer time/winter time changeover function

A requirement for the automatic S/W time changeover is that the current date is entered. If the time switch is set to AM/PM, the month is set with the key "h" and the date is set with the key "m".

Entering the current date

Press the keys "±1h" and "→Day" once simultaneously.

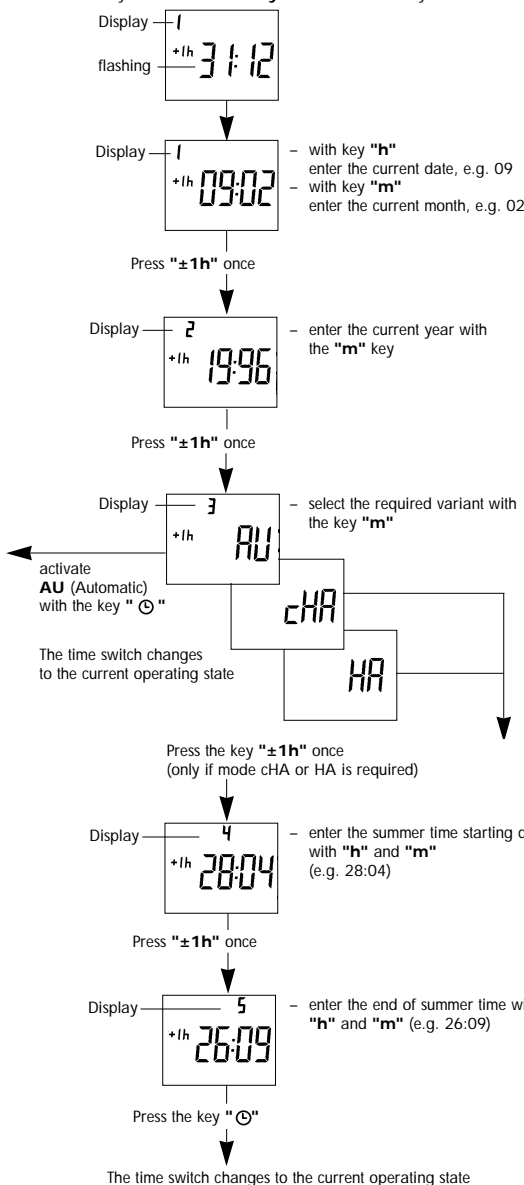

Reading the entered data

- Press the keys "±1h" and "Day" once simultaneously.
- Pressing the key "±1h" several times allows all entered data to be read in turn.
- The key "⊙" allows you to return to the current operating state at any time.

Changing the entered data

Changes can only be carried out in the variants CHA and HA.

- Press the keys "±1h" and "Day" once simultaneously
- Press the key "±1h" twice
- Select the variant CHA or HA with the key "m"
- Alter the changeover times as described in Figs. 1 to 5.

Deactivating the automatic S/W changeover function

- Press the keys "±1h" and "Day" once simultaneously.
- Press the key "h+" until "-- : --" appears (after the last day in the relevant month)
- Press the key "⊙": The clock changes to the current operating state.

The S/W time changeover can then be performed either manually by pressing the key "±1h" once or new data can be entered as shown in Figs. 1 to 5.

5.3 Manual switch

The current switching state can be changed at any time with the "⊙" key. Use of this manual override facility does not alter any of the programmed information.

Automatic Mode 	Manual Mode 	Continuous Operation
= ON	= OFF	= Continuous ON
= OFF	= ON	= Continuous OFF

The switching times correspond to the entered program.

If the current switching state is changed manually, the next switching command is again executed automatically according to the entered switching program.

You can only return to automatic mode from the and switching modes by pressing the "⊙" key.

5.4 Reading the programmed switching times

- Press the "Prog." key several times:
 - displays all entered switching times starting with the first memory location.
 - the first free memory location "-- : --" is then displayed.
 - the number of memory locations still free is then displayed
- If the memory locations are occupied, the following appears in the display: "FR 00"

- Press the "⊙" key:

The time switch changes to automatic mode and displays the current time.

5.5 Changing the programmed switching times

- Keep pressing the "Prog." key until the switching time to be changed is displayed.
- The new data can then be entered as described in Point 4.3.

Note on saving switching times:
If programming is not completed with the "⊙" key after the switching time is entered (4.3), the complete switching command is still automatically saved after approximately 90 seconds. The time switch then changes to automatic mode and shows the current time again

5.6 Deleting individual switching times

- Keep pressing the "Prog." key until the switching time to be deleted is displayed.
- Set to "-- : --" with the "h" or "m" key and then press the "⊙" key for about three seconds.

The switching time is deleted and the current time is displayed after the key is released.

5.7 AM/PM time display

If the "±1" key and the "h" key are pressed simultaneously, the time display is switched to AM/PM mode (used mainly in English-speaking countries).

5.8 Holiday program

Note:
The holiday program has priority over the standard week program. The holiday program can only be entered if all seven days of the week (1234567) are selected.

Enter switching times for the holiday period as described under 4.3. Whilst programming, the "⊙" key must be pressed to denote a holiday instruction.

The "⊙" key must be pressed for each switching time. Next, save the holiday switching times with the "Prog." or " " key.

Entering the start and duration of the holiday program

- After entering the switching times for the holiday program
- Press the "⊙" key once. The following image appears:

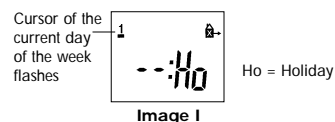

- If the holiday program is to start on a different day to the current one – max. 6 days ahead – use the "Day" key to select the day on which the holiday program is to commence.

If the holiday program is to be executed for up to max. 99 days, continue with steps 4 and 5.

If the holiday program is to be executed for an unlimited period, leave out step 4 and continue with step 5.

- Enter the required number of holiday days with the "Sel." key (1 to max. 99).
- Press the "⊙" key to save the entries.

If the current day of the week was entered as the holiday program start, the following appears:

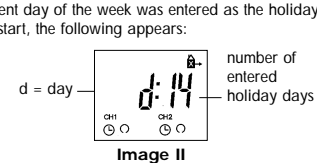

Image II remains until the holiday days have passed, for example d:10, d:09, d:08 etc.

Pressing the "⊙" key again and holding it down now allows the day of the week, the time and the current switching state – "⊙" = ON or "⊖" = OFF – to be checked.

If a day of the week other than the current day was entered as the holiday program start, the current time is displayed after the "⊙" key is pressed. The holiday program is then started at midnight at the start of the selected day of the week and its duration is displayed (Figure II).

After the programmed holiday days have expired, the current time appears in the display.

Aborting the holiday program prematurely

If the holiday program has already started:

- Press the "⊙" key once

If the holiday program has not yet started:

- Press the "⊙" key twice

6. Technical data

Connection	see unit imprint	Memory locations	42
Switching capacity	see unit imprint	Shortest switching time	1 min.
Ambient temp.	-10 °C to +55 °C	Programmable	every minute
Running reserve	see unit imprint	Protection	IP 20